

TH103

Universal Bending Jig

50mm Width
50kN Steel

TH103-AR3R55-OR10-Ni
Milled Radii R3 und R5
Upper Radius 10
Nickel
Range -70°C ...+350°C

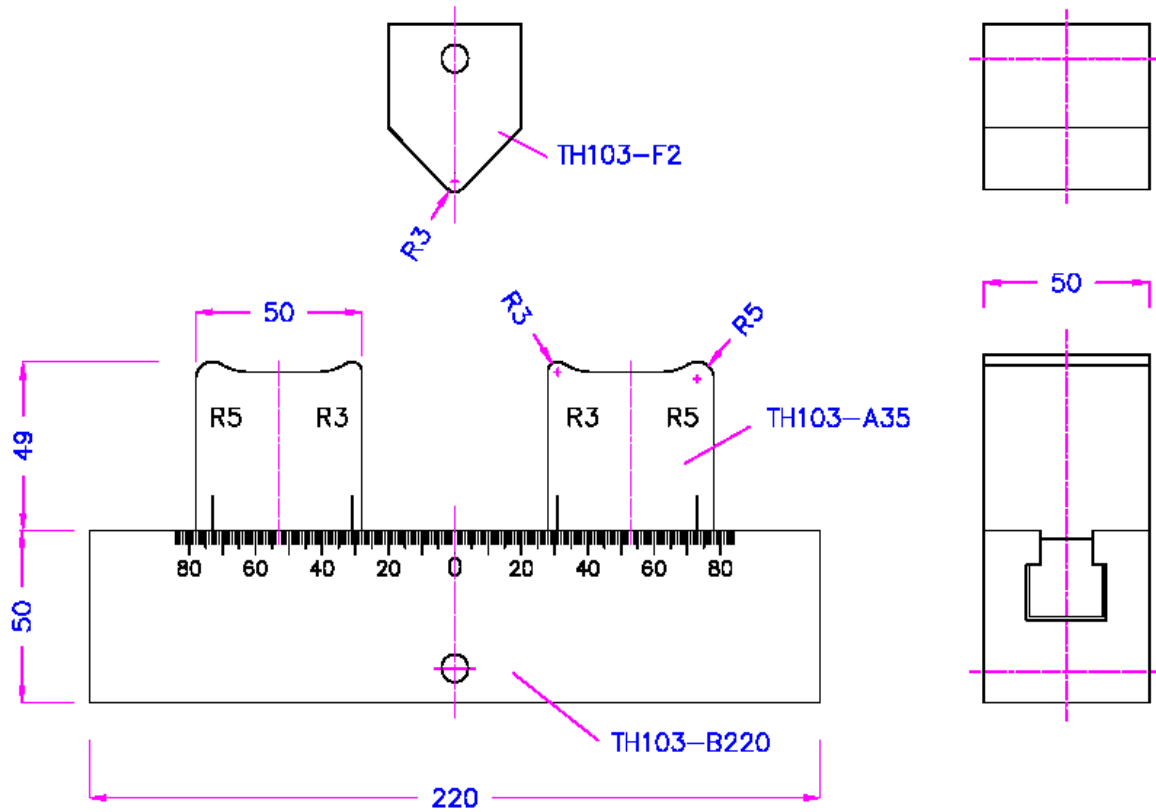
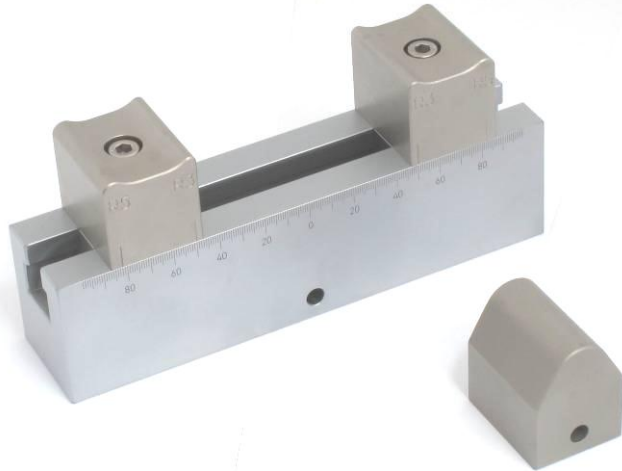

TH103-B220-AR2R5-oR3-cgr

Bending jig 50kN

with central adjustment
with milled supports
Radii R2 and R5
Shell radius R3
with spindle
for easier centric
Adjustment of the supports
0-70°C

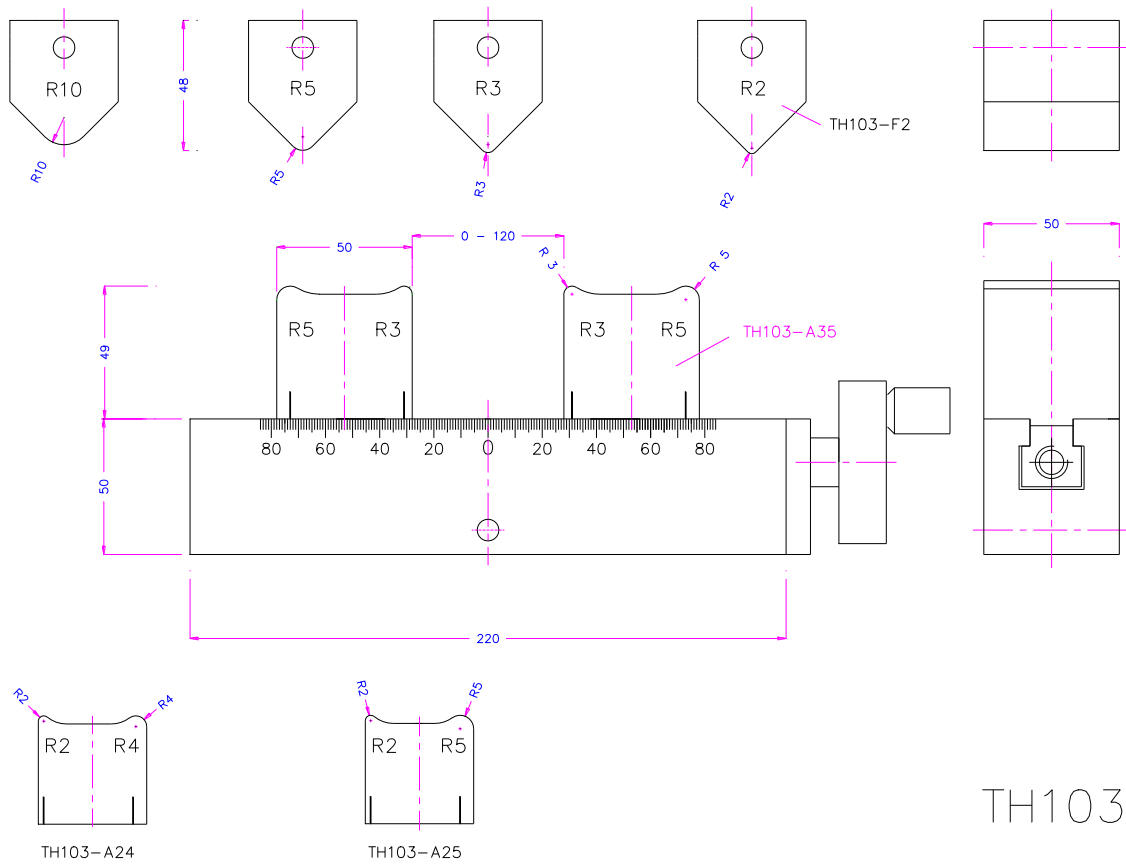
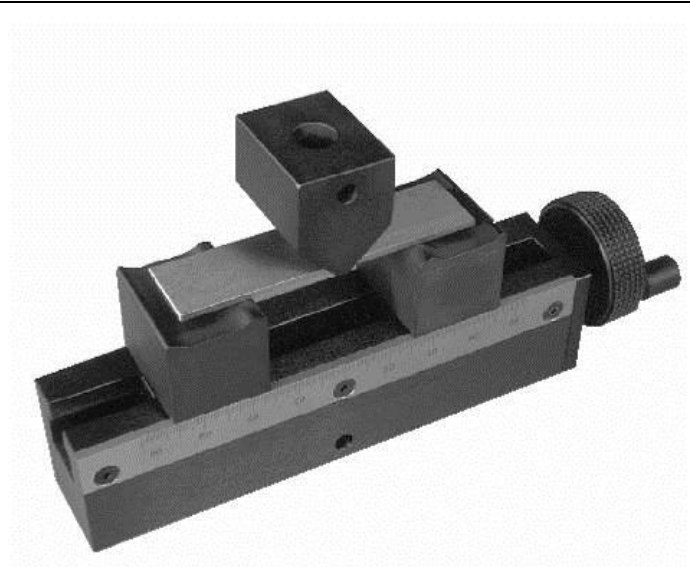

TH103

TH103-Ar3r5-or5-Af318

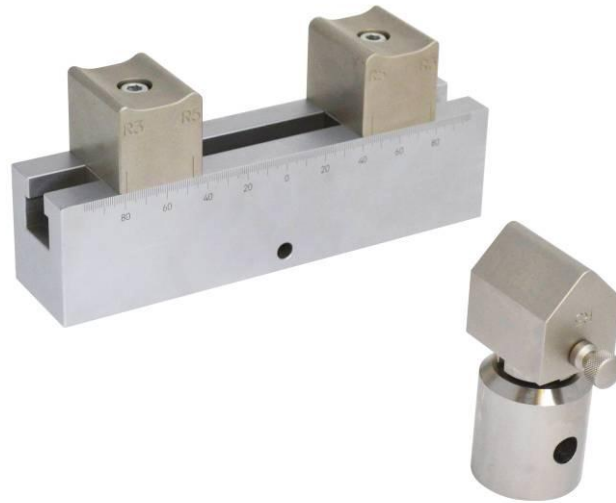

TH103-AXR2-AR3
-OR2-OR3-cgr

Exchangeable roller D3
+ D5

Upper milled Radii R2
and R3

3-point bending device
with central adjustment
lower supports with
interchangeable roller D3
and D5

Tops milled radius R2
and R3

Cgr centric gear

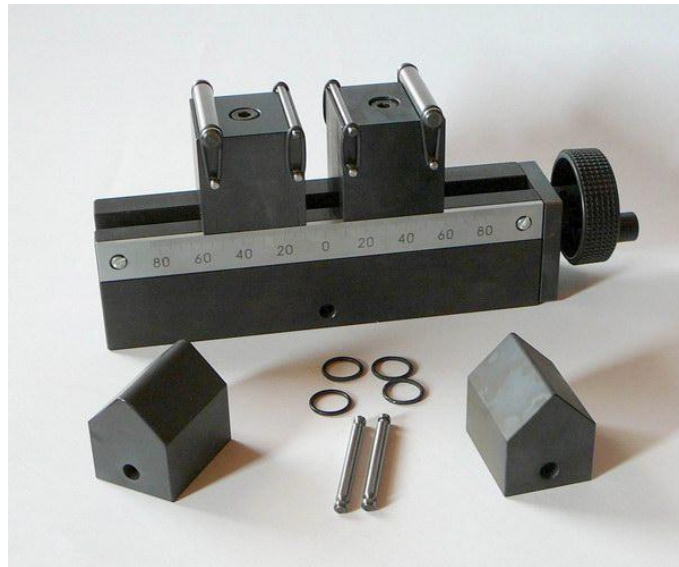

TH103-CWXD10



TH103-300-CR5-cgr-
A159
0-70°C- cgr



TH103-B300-AX50H80
-S9112-cgr

Extra long bar 300mm
Long upper fins
milled
for 160° bending
less load
0-70°C



TH103-CR5-OR30-cgr
0-70°C

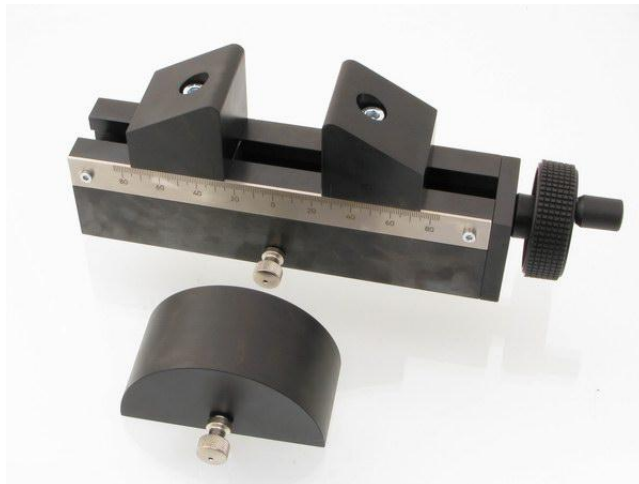

TH103-AX50-SL

With side bars for 180°
bending
0-350°C

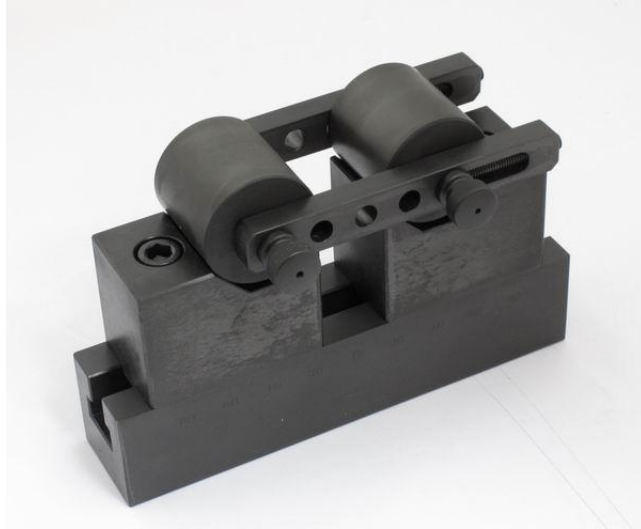

TH103-OT2-L150-
R4 R6.25 R12.5



TH103-ASTM-D2344

Rolling Table
0-180°C

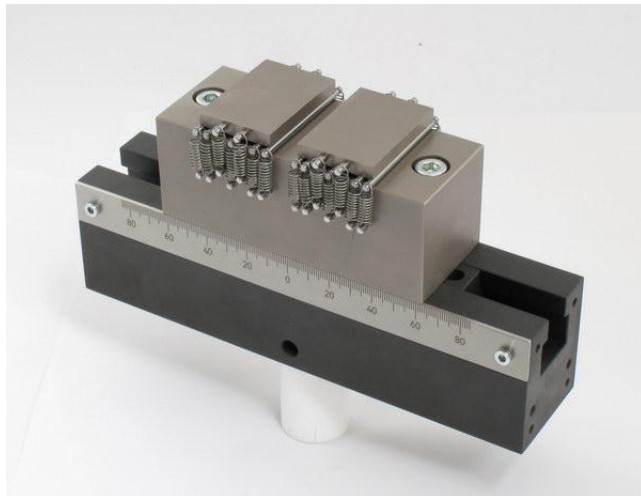

TH103-CR3-OR3+GDE

With guide ball bearings
0-70°C



TH103-Bo200-CR5-
Am22

Upper part
2 milled supports R5

Adapter 22 male
0-350°C



TH103-cl10-cgr-Af60

nur Unterteil

Rollen drehbar



TH103-CL20x50-
OR02x80-OR05x80- FV-
PWT-cgr

Faltvorrichtung

Folding device
DVS
DIN EN ISO7438
VDA238
0-70°C

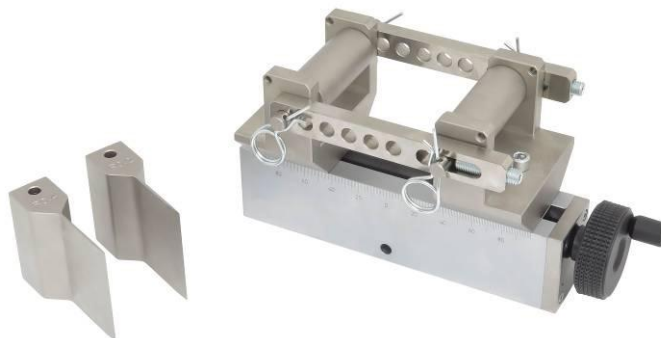

TH103 -AR2R5-ITH2-cgr

For external
extensometer
0-70°C



TH103-200-cwV8x5-HM-Af20

5mm Hartmetallrollen
Wippend

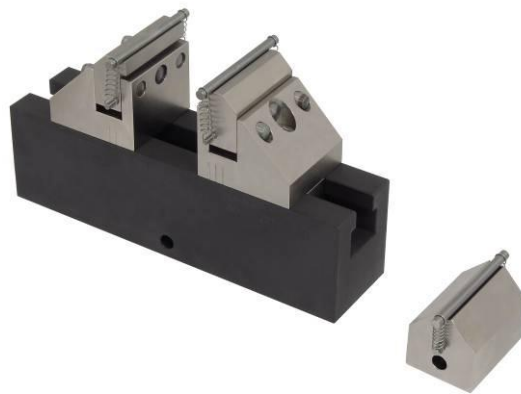

TH103-cwXD10

3 point bending fixture with
articulation fixable supports
with prism for roller diameter
4-16

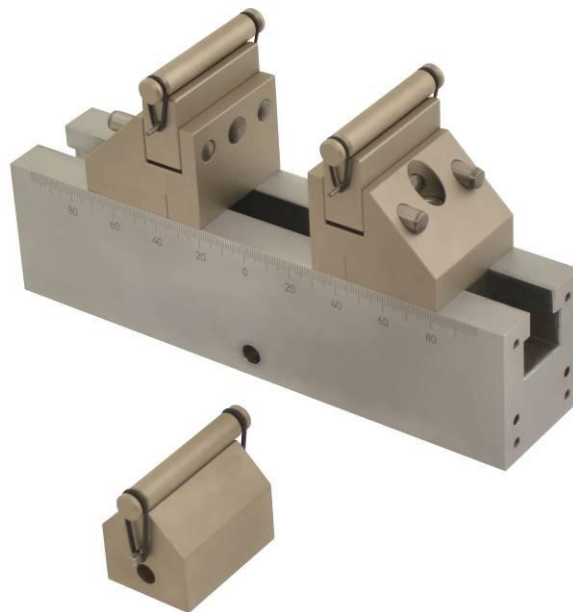

TH103-300-cWX3 + oWX3

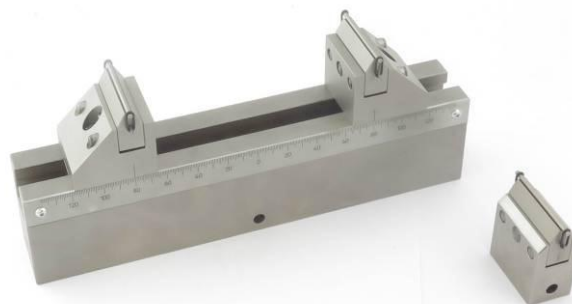

TH103-cWXv6d2-ith2

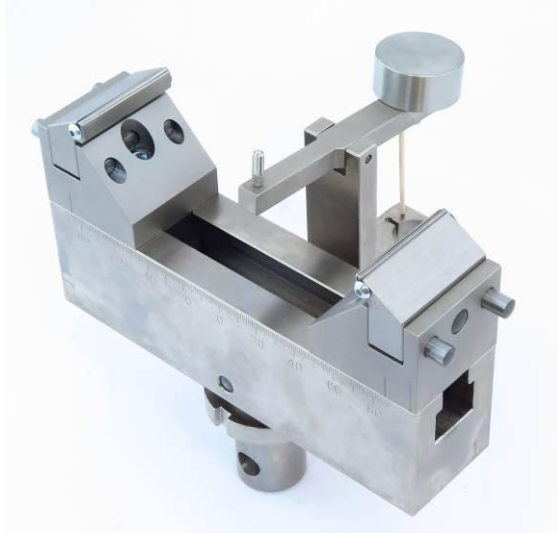

TH103-CWN8-ITH2-cgr

For external extensometer

Support moveable for
ceramics
0-70°C

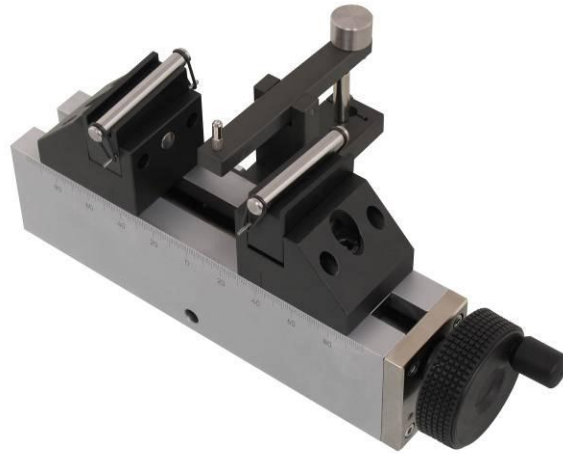

TH103-Bo200-CWN8-WDF

Upper 4P bending part

Support moveable for
ceramics
Extra Movable adapter
0-70°C



ASTM-D774
Material A4 (V4a)



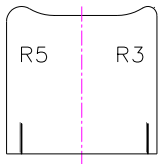

TH103-AR5R3
(2-4,2-5,3-5)

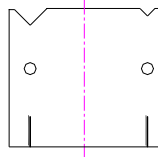

TH103-AX

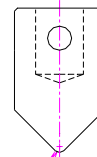

TH103-oR2-159
(Af159: 1.5,2,3,5,10,12.5)
(Af20: 2)
(Af318: 5)

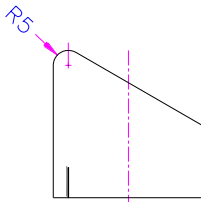

TH103-CR5
(1.5, 2, 4.5, 5)

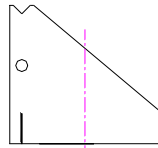

TH103-CX

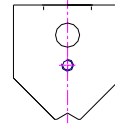

TH103-oX-159
(159, 19.1, 38)

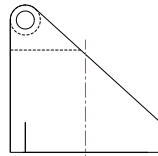

TH103-CL10

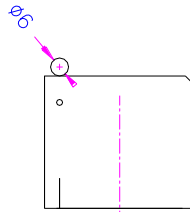

TH103-CM6

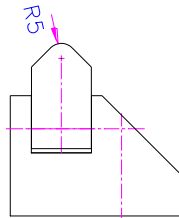

TH103-CWR5

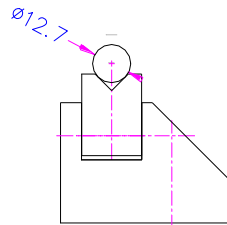

TH103-CWX127

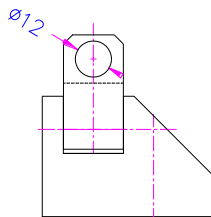

TH103-CWL12

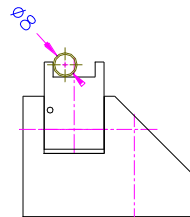





TH103-CWN8



TH103-D10
(4, 6, 10)

<p>Single parts</p>	
<p>TH103-B220-Af159 bar</p> <p>220mm lang Adapter15.9</p> <p>Basis Bar Length 0-350°C -70-+350°C nickel</p>	
<p>TH103-B220-Af159-cgr</p> <p>Bar with centric gear</p> <p>Basis Bar Length 0-70°C</p>	
<p>TH103-BK300-Af159</p> <p>Bar 300mm with centric gear 0-70°C</p>	
<p>TH103-Bo200-Af159</p> <p>Upper bar 200mm for 4P bending Adapter female 15.9mm</p>	

<p>Supports</p>	
<p>TH103-AR2R4</p> <p>Milled hardened black</p>	
<p>TH103-Cr5</p> <p>Suitable for 4P bending r1.5, r2, r5, r10</p>	
<p>TH103-AX</p> <p>Prisma inserts For roller with 3..15 mm diameter Height 51.5 ..62.9mm</p>	
<p>TH103-D10 TH103-D6 TH103-D4</p> <p>Roller</p>	

TH103-CR5

milled



TH103-CL10-Ni

Turnable roller
Dia 10mm
nickeled







TH103-CWN8

Moveable Roller 8mm dia
Fre rotating on flat surface
kept with o-Ring

for ceramic samples



<p>TH103-o upper single fin</p>	
<p>TH103-oR2 Radius R2 Milled hardened</p>	
<p>TH103-FX For exchangeable roller 3-10mm dia</p>	
	<p>Special</p>
<p>TH103-oR10H80 R10 milled Height 80mm hardened</p>	
<p>TH103-oR02-FV R0.2 for 160° bending</p>	

<p>TH103-oR50</p> <p>Radius R50</p>	
<p>Additional accessories</p>	
<p>TH103-SL220</p> <p>Side bar for 180° bending</p>	
<p>TH103-iTH2</p> <p>Holder for external extensometer</p>	